

## Kruhové prídavné stoly

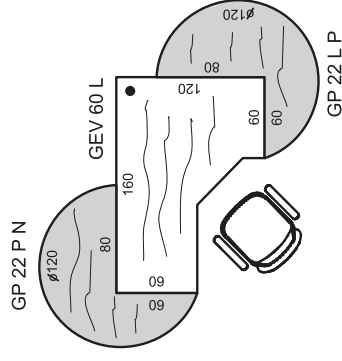

Príklad označenia:  
 GP 22 P N  
 P = prevedenie pravé  
 N = smer kresby "naprieč"  
 GP 22 L P  
 L = prevedenie ľavé  
 P = smer kresby "pozdiž"

## Kvapkovité prídavné stoly

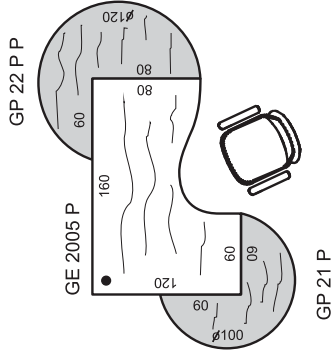
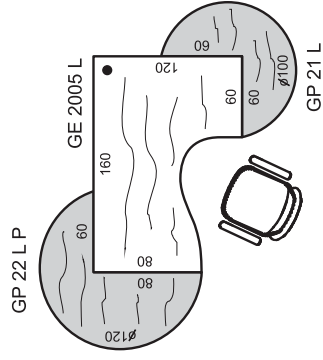
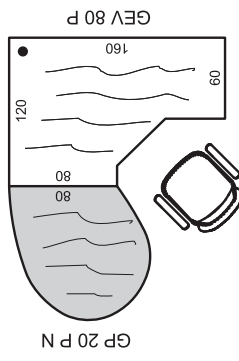
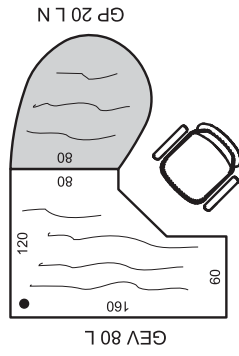
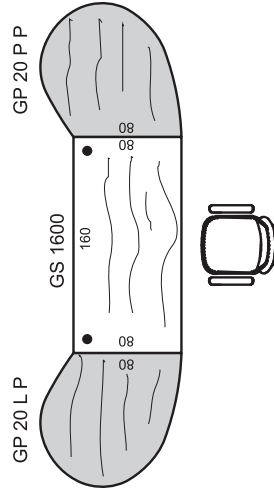

Príklad označenia:  
 GP 20 L N  
 L = prevedenie ľavé  
 N = smer kresby "naprieč"  
 GP 20 P P  
 P = prevedenie pravé  
 P = smer kresby "pozdiž"

## Štvrtkruhové prídavné stoly

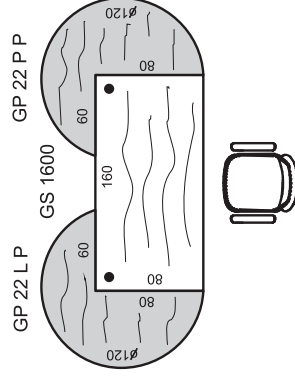
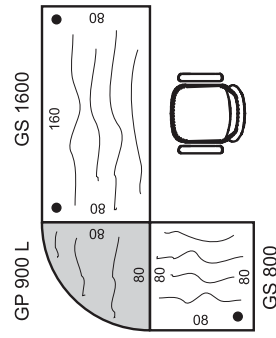
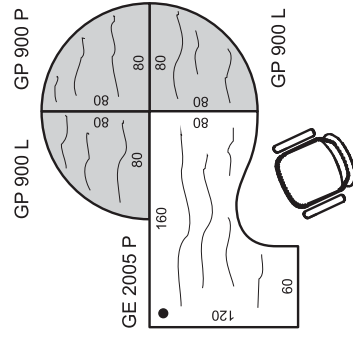

## Roletová skriňa k stolu SPR 80 60

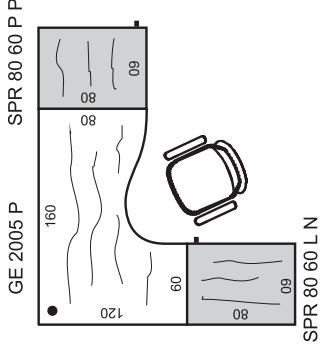
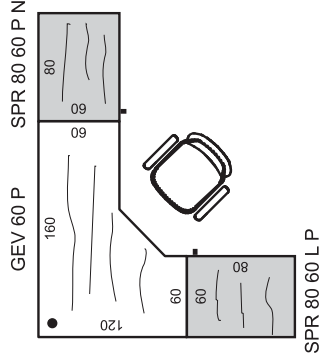
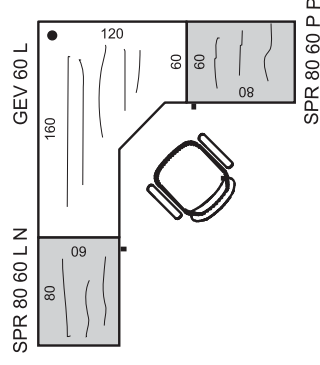

Príklad označenia:

SPR 80 60 P P, SPR 80 60 P N  
(P = otváranie vpravo, P = smer kresby "pozdĺž")  
SPR 80 60 L N, SPR 80 60 L P  
(L = otváranie vľavo, N = smer kresby "naprieč")

## Kontajnery

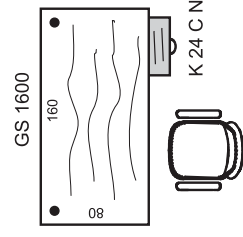
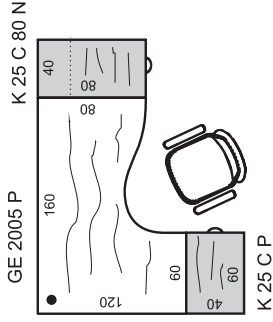
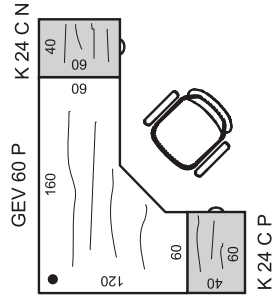

Príklad označenia:

K 24 C N (N = smer kresby "naprieč")  
K 24 C P (P = smer kresby "pozdĺž")

K 25 C 80 - kontajner s horným dnom hĺbky 80 cm, t.j. rovnako s hĺbkou pracovného stola.

## Kontajnery

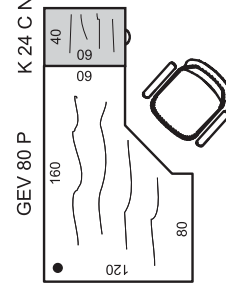
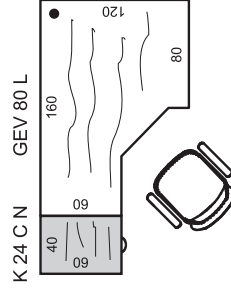

Rohové skrine delíme podľa umiestnenia v zostave na P (pravé) a L (ľavé).  
Je dôležité tento údaj uviesť v objednávke!

## Rohové skrinky